

DA 3800 Flange Inlet

Technical Info

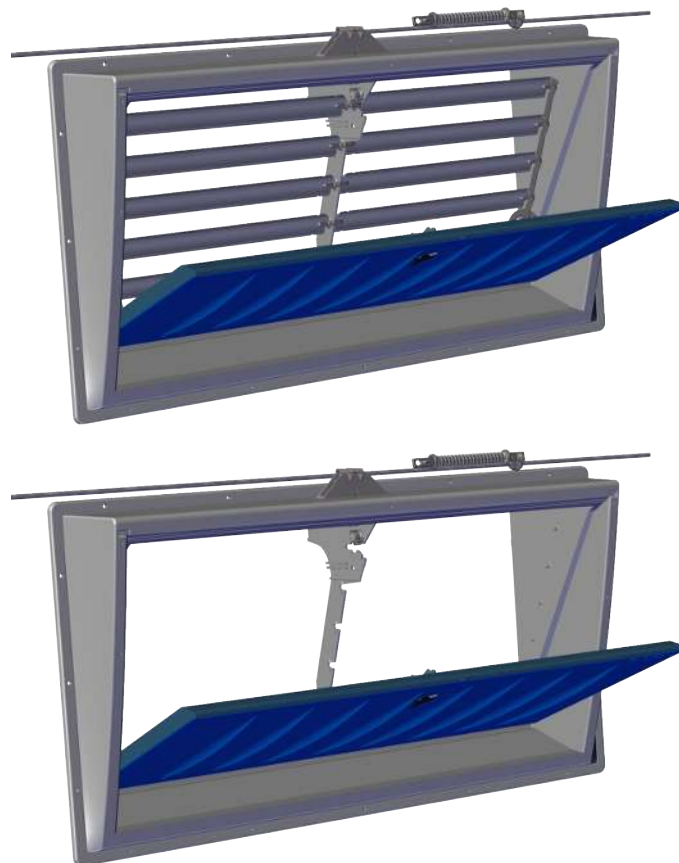

1 Product description

The DA 3800 flange inlet is a large universal wall inlet, which is used for ventilating livestock houses with LPV or Combi-Tunnel ventilation.

The flange inlet can be adapted to wall thicknesses up to 35 cm employing an extension piece. The inlet is fixed on the inside wall by screws through the flange itself. It cannot be built or cast directly into wall elements.

The DA 3800 flange inlet is available with Advanced Inlet Control (AIC), which makes it easy to adjust the air intake following the current conditions.

The DA 3800 is also available with Advanced Flow Control (AFC), which provides high pressure stability and optimum airflow from minimum to maximum ventilation.

The DA 3800 flange inlet is easy-to-clean because of its open and smooth design.

The inlet is made of a highly impact-proof material; it is dimensionally stable and 100% recyclable.

DA 3800 flange inlet is protected by several patents.

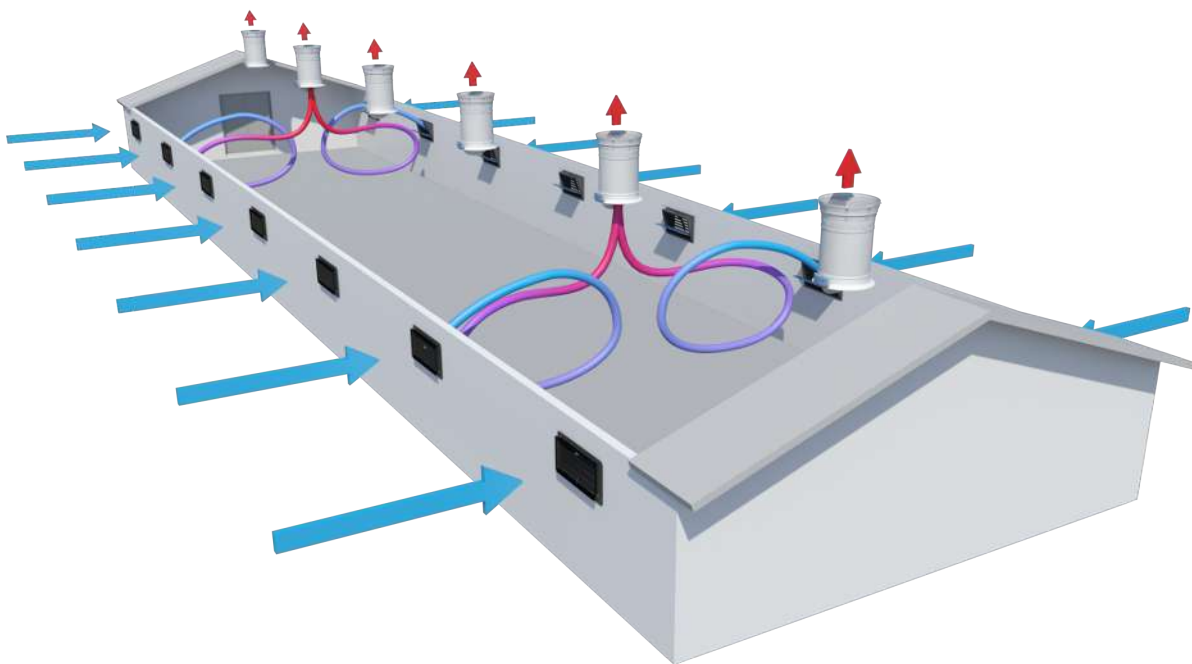

2 Product survey

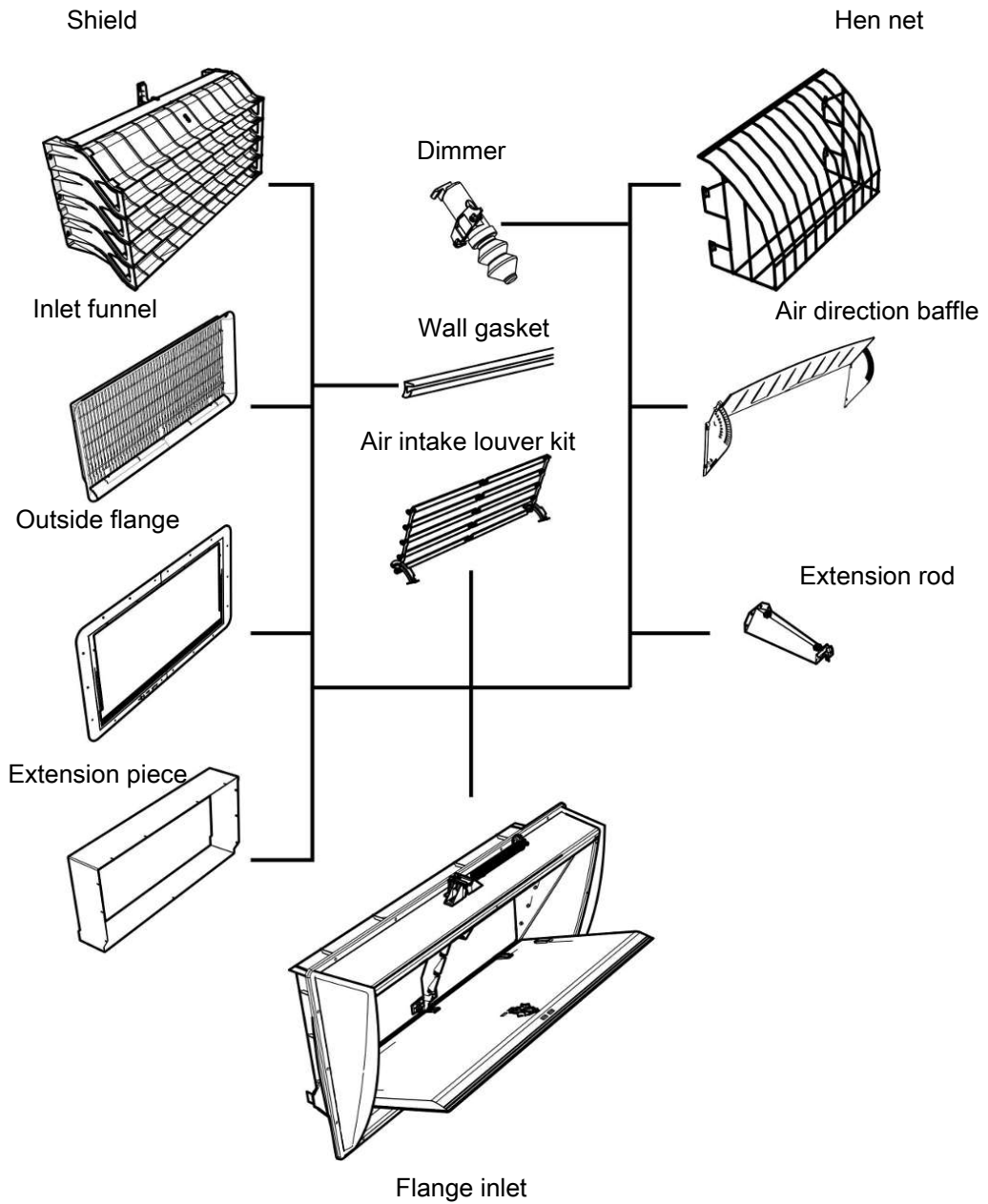

2.1 Flange inlet

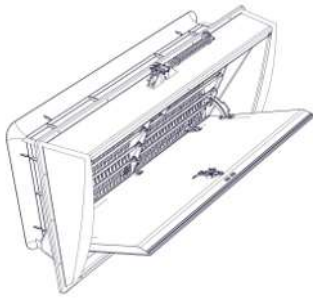

433354 DA 3800 AFC flange inlet w/inlet funnel

It is used for ventilation of livestock buildings. The flange inlet is available with Advanced Flow Control (AFC), which provides high pressure stability and optimum airflow from minimum to maximum ventilation.

The inlet funnel incl. coarse net is used to improve performance as well as avoid the ingress of birds and larger animals.

It comes with spring unit, parts for mounting on pull rod, and differentiation.

The 14 screws for mounting must be ordered separately. When mounting in a sandwich wall, 351585 can be used.



433374 DA 3800 AFC flange inlet wo/inlet funnel

It is used for ventilation of livestock buildings. The flange inlet is available with Advanced Flow Control (AFC), which provides high pressure stability and optimum airflow from minimum to maximum ventilation.

It comes with spring unit, parts for mounting on pull rod, and differentiation.

The 14 screws for mounting must be ordered separately. When mounting in a sandwich wall, 351585 can be used.

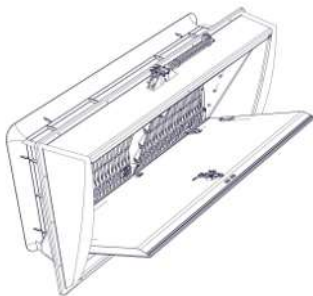

433353 DA 3800 flange inlet w/inlet funnel

It is used for ventilation of livestock buildings.

The inlet funnel incl. coarse net is used to improve performance as well as avoid the ingress of birds and larger animals.

It comes with spring unit, parts for mounting on pull rod, and differentiation.

The 14 screws for mounting must be ordered separately. When mounting in a sandwich wall, 351585 can be used.



433373 DA 3800 flange inlet wo/inlet funnel

It is used for ventilation of livestock buildings.

It comes with spring unit, parts for mounting on pull rod, and differentiation.

The 14 screws for mounting must be ordered separately. When mounting in a sandwich wall, 351585 can be used.

2.2 Accessories

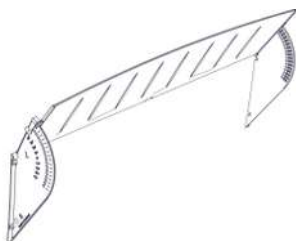

433355 DA 3800 air direction baffle

The air direction baffle is used to direct/correct the air jet vertically.

The air direction baffle may reduce the need for covering small obstacles ($h < 100$ mm) on the ceiling surface.

It comes with screws, brackets, and positioning lock.

One per inlet.



433364 DA 3800 screen

It is used for protection against direct light incidence, wind, and driving rain.
The 10 screws for mounting must be ordered separately. When mounting in a sandwich wall, 351585 can be used.
One per inlet.



433358 DA 3800 outside flange

It is used where a closed wall transition is required on the outside.
The 14 screws and 14 washers for mounting must be ordered separately.
When mounting in a sandwich wall, 433375 can be used.
One per inlet.

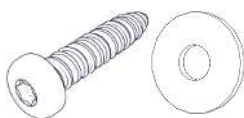

433375 DA 3800 screw kit f/outside flange

Used when mounting the DA 3800 outside flange in sandwich walls.



433359 DA 3800 extension rod 40 cm

The extension rod is used if you want to run the pull rod round heavy concrete pillars or the like, where it is not possible to run the pull rod directly through the pillar by making a through-going hole.
It is supplied with an 1850 mm nylon cord.
The 4 screws for mounting must be ordered separately. When mounting in a sandwich wall, 351585 can be used.
One per inlet.

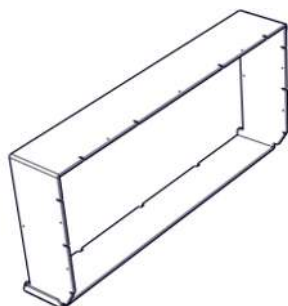

433371 DA 3800 extension piece 14 cm

Used for wall dimensions from 14-24 cm.

433369 DA 3800 extension piece 17.5 cm

Used for wall dimensions from 24-27.5 cm.

433370 DA 3800 extension 25.5 cm

Used for wall dimensions from 27.5 to 35 cm.

The extension must be used together with the inlet funnel and the inlet when the wall thickness exceeds 13 cm.

If an extension piece is to be used on a flange inlet without inlet funnel (433354 and 433373), 433352 inlet funnel must always be ordered, as it contains an insulation piece.

It comes with mounting screws.

One per inlet.

**433352 DA 3800 inlet funnel**

The inlet funnel incl. coarse net is used for retrofitting to improve performance as well as avoid the ingress of birds and larger animals.

Inlet funnel contains an insulation piece for insulation.

Click it directly onto the inlet.

One per inlet.

**433360 DA 3800 hen net**

It is used to prevent the birds from sitting on the inlet flap.

Cannot be used together with the air direction baffle.

It comes with mounting fitting.

The air output is not influenced by the hen net.

One per inlet.

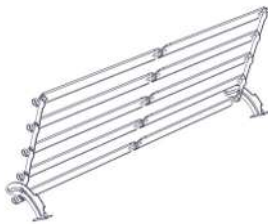
**433363 DA 3800 louver kit**

Used when retrofitting of Advanced Flow Control (AFC)T, which provides high pressure stability and optimum airflow from minimum to maximum ventilation, is required. Note that in case of new sale, the following part no. should be offered instead: 433354 and 433353 with inlet funnel including louver kit/AFC.

One per inlet.

**433381 DA 3800 wall gasket**

Used as a gasket between the wall and DA 3800 flange inlet. Can in most cases replace the manual point process.

To be mounted on the inlet frame.

One per inlet.

**433372 DA 3800 damper for flap**

Used in areas with a risk of strong gust of wind.

Strong gusts of wind on the leeward side of the building can create a high negative pressure that can close the inlet flap for a short time. The damper prevents the sound effect that can occur and disturb the animals in these cases.

One per inlet.

**351585 Tapp. screw 5x30 pan TX25 ZnNi spec.**

Used when mounting the DA 3800 and accessories in sandwich walls.

3 Technical data

Mechanical		
Material		HIPS, PPO, POM, PA, PP
Color		Gray, Blue, Black
Net size inlet funnel	mm	15 x 67
Tensile force per inlet	kg	12
Tensile length with spring unit on pos. 1	mm	490
Air output at -10 Pa, wall thickness 5-35 cm		
DA 3800 flange inlet w/inlet funnel + AFC	m ³ /h	3800
DA 3800 flange inlet w/inlet funnel + AFC and shield	m ³ /h	3600
DA 3800 flange inlet w/inlet funnel	m ³ /h	3950
DA 3800 flange inlet w/inlet funnel + shield	m ³ /h	3600
DA 3800 flange inlet w/AFC	m ³ /h	3550
DA 3800 flange inlet w/AFC + shield	m ³ /h	3650
DA 3800 Flange Inlet	m ³ /h	3100
DA 3800 flange inlet w/shield	m ³ /h	2950
Environment		
Temperature, operation	°C (°F)	-30 to +50 (-22 to +122)
Storage temperature	°C (°F)	-40 to +60 (-40 to +140) – and protected against direct sunlight.
Ambient humidity, operation	% RH	0-95 % RH
Shipment		
Flange inlet w/inlet funnel AFC [H x W x D]	mm	1067 x 581 x 335
Flange inlet ex/inlet funnel AFC [H x W x D]	mm	1067 x 581 x 285
Flange inlet w/inlet funnel [H x W x D]	mm	1067 x 581 x 335
Flange inlet ex/inlet funnel [H x W x D]	mm	1067 x 581 x 285
Flange inlet w/inlet funnel AFC, weight	g	9000
Flange inlet ex/inlet funnel AFC, weight	g	8300
Flange inlet w/inlet funnel, weight	g	8200
Flange inlet ex/inlet funnel, weight	g	7500

3.1 Dimensioned sketch

In mm.

3.1.1 DA 3800

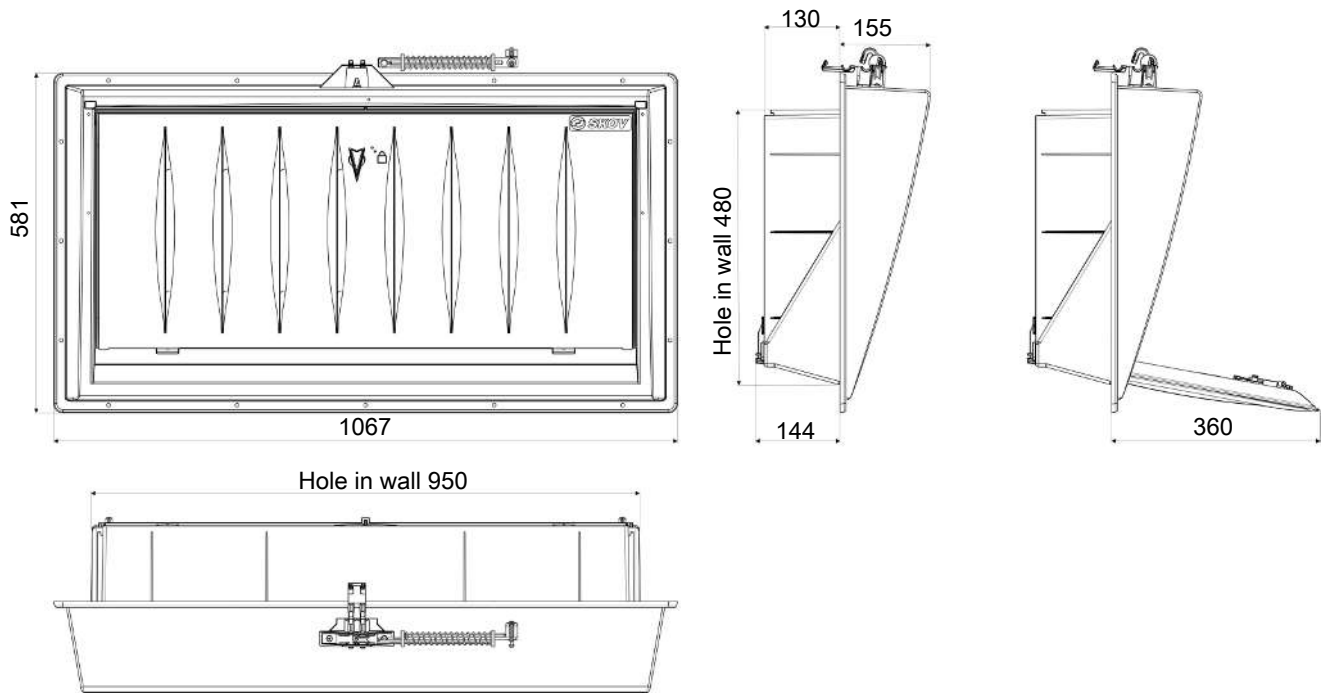

3.1.2 Inlet funnel

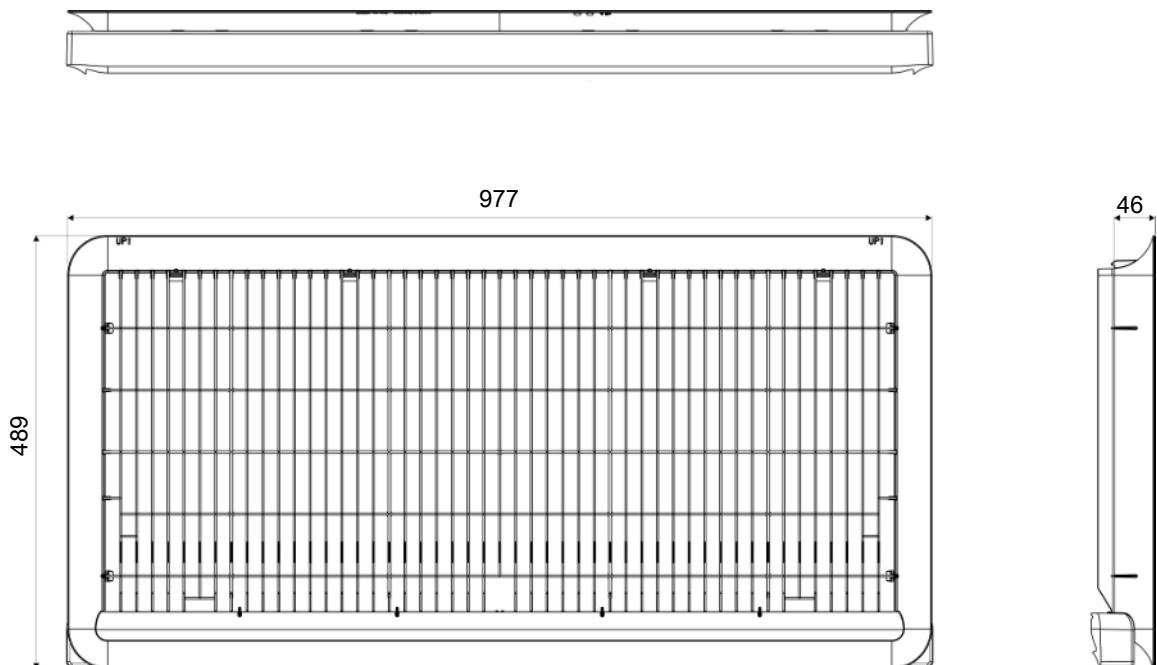

3.1.3 Air direction baffle

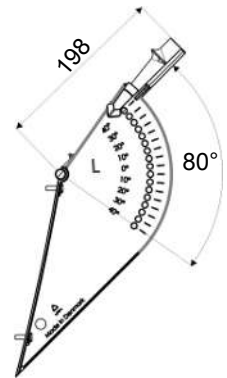
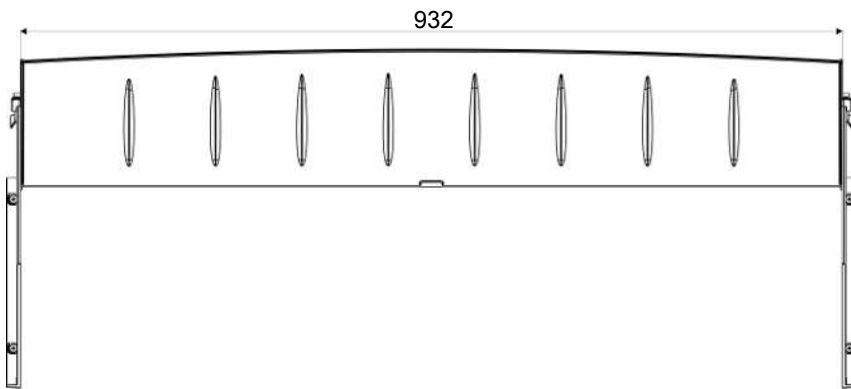

3.1.4 Shield

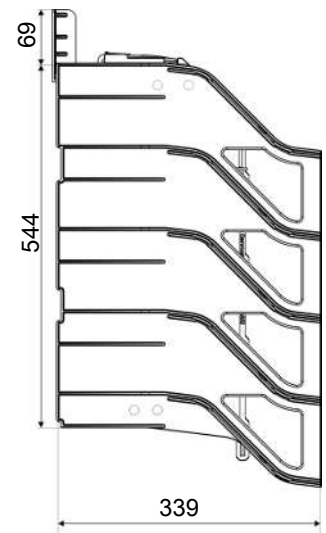
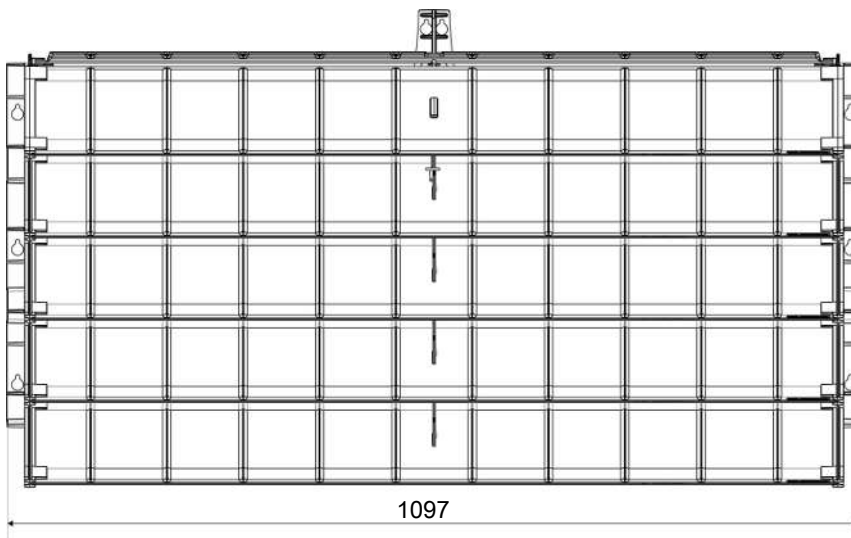

3.1.5 Hen net

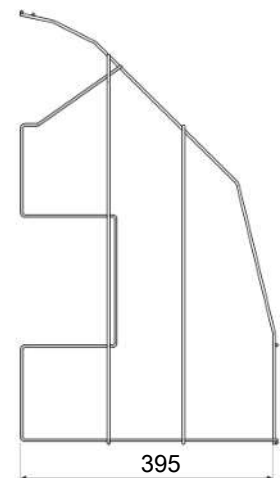
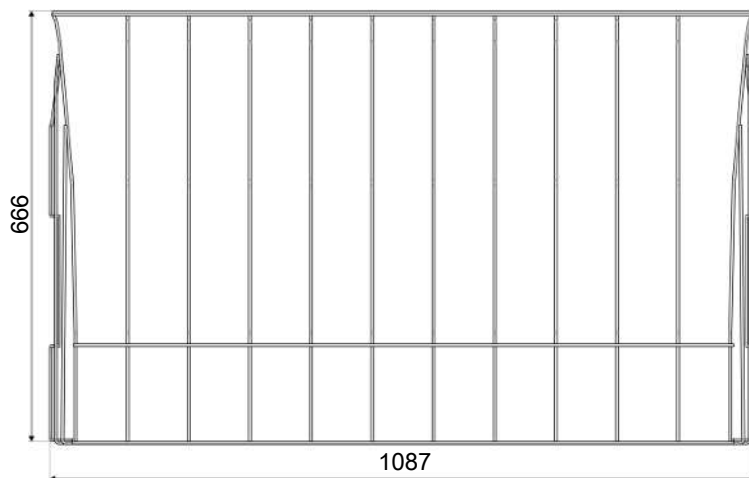

SKOV A/S • Hedelund 4 • Glyngøre • DK-7870 Roslev
Tel. +45 72 17 55 55 • www.skov.com • E-mail: skov@skov.dk

